

# Installation Guide

DC250 - stand alone access control unit for 250 users



## 1 Locating the control Unit

The DC250 control unit should be fitted close to the door through which you wish to control access. It should be on the secure side. When programming the unit you will need access to both the reader and controller, therefore you should arrange them reasonably close together.

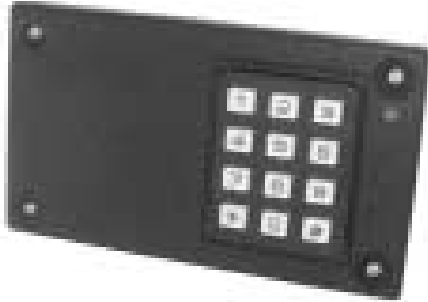

## 2 continued

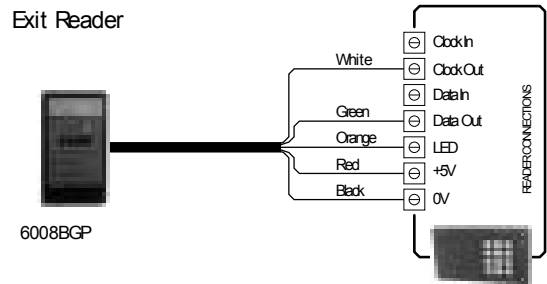
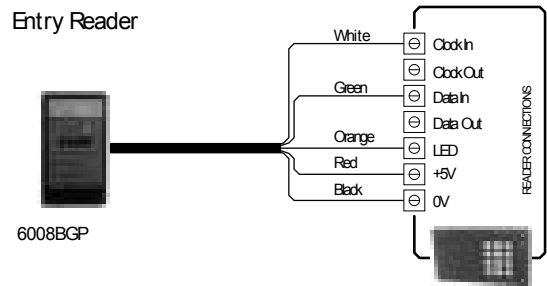

## 2 Connecting the reader(s)

The DC250 can control access both in and out of the controlled door when two readers are connected. Choose any clock and data format reader.

When supplied in kit form, you have a choice of the SRS MR4 mag. stripe reader (40010041) or the HID proximity reader (6008BGP). One reader is supplied with the kit, but you can install a second 'Exit' reader if required.

## 3 Egress button

Pressing the egress button (push to make switch) will operate the door opening timer. The timer starts when the button is pressed and released, a time clock may be used for real time door unlocking.

### Entry Reader

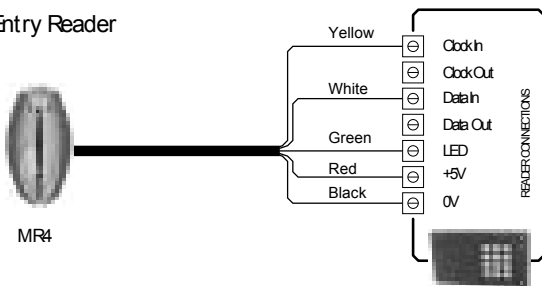

### Exit Reader

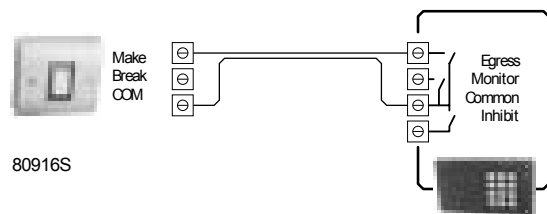
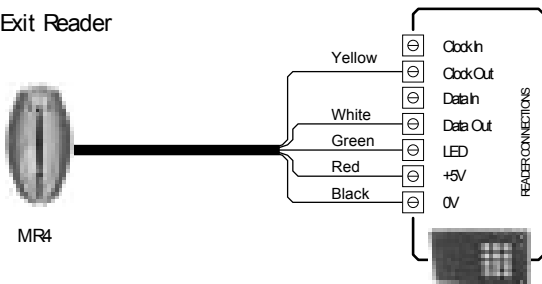

## 4 Time Clock

Closing contacts from a time clock or simple switch will disable token operation (eg. out of hours). The Egress input will still function.

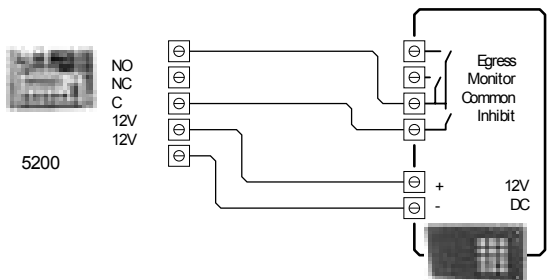

## 5 Door Monitor

Door Monitor contact input, if fitted will re-lock the door 2 seconds after door opens. A monitored release or lock may be used in place of a contact.

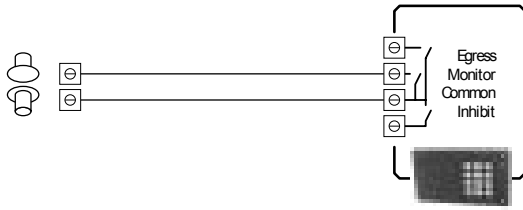

## 6 Locking device

The Lock release should match the supply input and have a lock suppressor connected directly across its terminals (as shown & supplied).

### Locking - Fail Locked

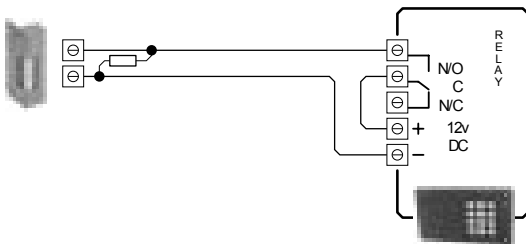

### Locking - Fail Unlocked

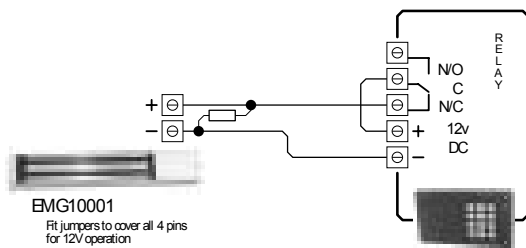

## 7 Break Glass

If the controlled door is on a fire escape route you should fit fail safe locking devices and a break glass unit for emergency exit.

### Locking - Fail Unlocked

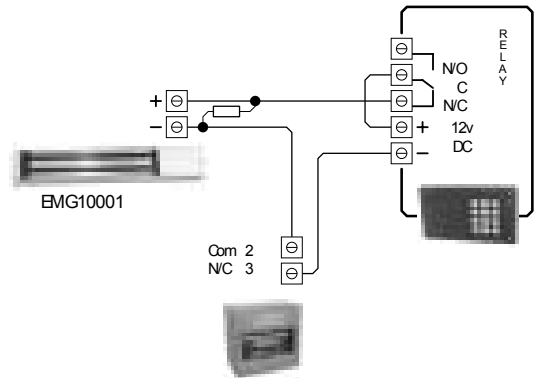

## 8 Power supply

With no locks connected, DC250 Access Control Unit power consumption is 12v dc 20mA (quiescent) and 150mA (operating)

Maximum power available for lock (from 9012 power supply provided) is 12v dc 1A (continuous)

Maximum lock relay contact rating is 24vDC 2A

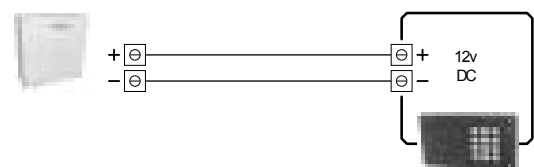











## 9 Setting the Programming Code

You should set your OWN programming code since the factory set code (123456) is easy to guess.

- While holding down the "x" key, apply the D.C power. A one second tone will be heard. Release the key when the tone stops.
- Enter the desired NEW six digit Programmers Code of your choice eg. "666666". A confirmation tone will be heard.
- To program cards into the unit refer to the User Instructions.

# Appendix

DC250 - stand alone access control unit for 250 users

	DC250	40010014	6008BGP	9012	22401	1326	615112A	EMG10001	114411	80916S	code
											
	contents of kit										
SYSTEM EXAMPLES	●	●		●	●						KDC250M
	●	●		●	●		●				KDC250MR
	●	●		●	●			●	●	●	KDC250MM
	●		●	●		●					KDC250P
	●		●	●		●	●				KDC250PR
	●		●	●		●		●	●	●	KDC250PM

These kits offer you a choice of locking and a choice of reader options