



Audio Door Entry

Video Door Entry

Access Control Systems

Installation Accessories



SD audio kit



Key features are the very small size of the panel and the intercom facility when you have an extra telephone (max 3 phones). The kit includes 12V DC plug in PSU adapter.

- robust slim aluminium panel
- surface mounted
- stylish phone with intercom call
- only 2 wires
- volt free lock button

Wiring Layout

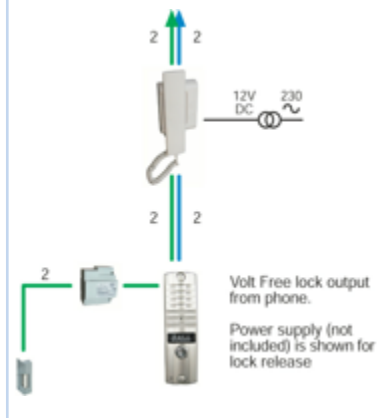

Description	Code
1 phone kit	SDK-7D6S
Extra phone	SD720AR7
Lock power supply	9307.1

	Height	Width	Depth
Panel	128	40	30
Phone	210	95	50

KET audio kit



A range of audio door entry kits with surface mounted aluminium panel. A key feature of the panel is its unique hinge which allows trouble free installation.

- 1-12 call buttons
- Surface mounted
- Only 110 mm wide
- Only 25 mm deep
- The panel faceplate is hinged for easier installation
- 4+n wiring

Wiring Layout

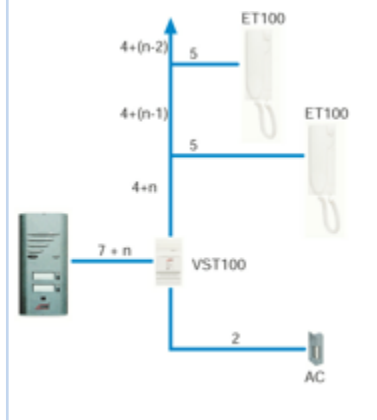

Description	Code
1 phone kit	KETV01
2 phone kit	KETV02
3 phone kit	KETV03
4 phone kit	KETV04
6 phone kit	KETV06
8 phone kit	KETV08
10 phone kit	KETV10
12 phone kit	KETV12
Extra phone	ET100

	Height	Width	Depth
1 way panel	208	110	25
2 way panel	234	110	25
3 way panel	261	110	25
4 way panel	234	110	25
6 way panel	261	110	25
8 way panel	287	110	25
10 way panel	313	110	25
12 way panel	339	110	25
Phone	220	83	50

Doorpoint kit



Key features are the size of the vandal resistant hinged panel, 12V AC/DC lock outputs and the timed lock relay.

- Call up to 4 handsets simultaneously
- Only 100mm wide (ideal for gate posts)
- BS316 stainless steel
- Hinged for easier installation
- Surface mount panel

Wiring Layout

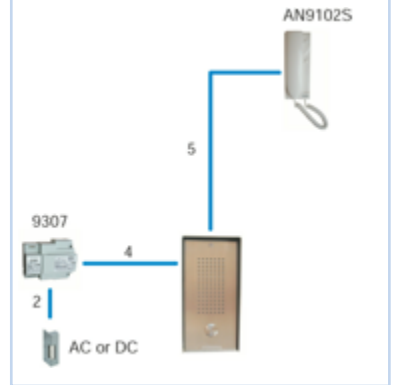

Description	Code
1 phone kit	K5101S
Extra phone	AN9102S

	Height	Width	Depth
5101S panel	200	100	50
Phone	220	83	50

Doorpoint kit with keypad



Key features are the size of the vandal resistant hinged panel, 12V AC/DC lock outputs and the timed lock relay.

- Call up to 4 handsets simultaneously
- Only 100mm wide (ideal for gate posts)
- BS316 stainless steel
- Surface mount panel
- Hinged for easier installation
- Built in 100 code keypad with 2 relays

Wiring Layout



Description	Code
1 phone kit + keypad	K5105S
Extra phone	AN9102S

	Height	Width	Depth
5101/05S keypad panel	280	100	50
Phone	220	83	50

Engravable 4000 series audio kits



SRS vandal resistant panels have been manufactured to the highest standards since 1987.

- BS316 marine grade stainless steel construction
- Hinged for easier installation
- All kits up to 10 way in stock for same day despatch
- 12V AC/DC power output for locking
- Timed lock release
- Excellent audio quality
- Kits available with up to 60 call buttons

Wiring Layout

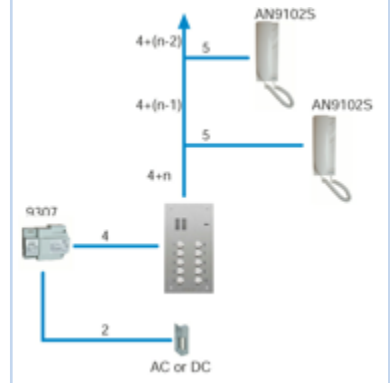

Description	Code
1 phone kit	K4101
2 phone kit	K4102
3 phone kit	K4103
4 phone kit	K4104
5 phone kit	K4105
6 phone kit	K4106
7 phone kit	K4107
8 phone kit	K4108
9 phone kit	K4109
10 phone kit	K4110
Surface mount hood	3505/50
Extra phone	AN9102S

	Height	Width	Depth
4101 panel	250	136	50
4102 panel	250	136	50
4103 panel	250	136	50
4104 panel	250	136	50
4105 panel	250	136	50
4106 panel	250	136	50
4107 panel	250	136	50
4108 panel	250	136	50
4109 panel	250	136	50
4110 panel	250	136	50
3505/50	254	140	65
Phone	220	83	50

with keypad

As vandal resistant panel with built in keypad for user access.

- 110 code keypad with 2 relays
- keypad is illuminated



Description	Code
1 phone kit	K4101/05
2 phone kit	K4302/05
3 phone kit	K4303/05
4 phone kit	K4304/05
5 phone kit	K4305/05
6 phone kit	K4306/05
7 phone kit	K4307/05
8 phone kit	K4308/05
9 phone kit	K4309/05
10 phone kit	K4310/05
Surface mount hood	3505/50
Surface mount hood	3506/50
Extra phone	AN9102S

	Height	Width	Depth
4101/05 panel	250	136	50
4302/05 panel	321	181	50
4303/05 panel	321	181	50
4304/05 panel	321	181	50
4305/05 panel	321	181	50
4306/05 panel	321	181	50
4307/05 panel	321	181	50
4308/05 panel	321	181	50
4309/05 panel	321	181	50
4310/05 panel	321	181	50
3505/50	254	140	65
3506/50	325	185	65
Phone	220	83	50

with proximity

As vandal resistant panel with built in proximity reader and controller for user access.

- 250 users
- Illuminated



Description	Code
1 phone kit	K4101/08
2 phone kit	K4302/08
3 phone kit	K4303/08
4 phone kit	K4304/08
5 phone kit	K4305/08
6 phone kit	K4306/08
7 phone kit	K4307/08
8 phone kit	K4308/08
9 phone kit	K4309/08
10 phone kit	K4310/08
Surface mount hood	3505/50
Surface mount hood	3506/50
Extra phone	AN9102S

	Height	Width	Depth
4101/08 panel	250	136	50
4302/08 panel	321	181	50
4303/08 panel	321	181	50
4304/08 panel	321	181	50
4305/08 panel	321	181	50
4306/08 panel	321	181	50
4307/08 panel	321	181	50
4308/08 panel	321	181	50
4309/08 panel	321	181	50
4310/08 panel	321	181	50
3505/50	254	140	65
3506/50	325	185	65
Phone	220	83	50

Name Window 4000 series audio kits



- SRS Name window panels come with clear polycarbonate windows, where you can print flat numbers
- Name window is illuminated green
- Alternatively stainless steel name plates are available from stock (or engraved same)

SRS vandal resistant panels have been manufactured to the highest standards since 1987.

- BS316 marine grade stainless steel construction
- Hinged for easier installation
- All kits up to 10 way in stock for same day despatch
- 12V AC/DC power output for locking
- Timed lock release
- Excellent audio quality
- Kits available with up to 30 call buttons

Wiring Layout

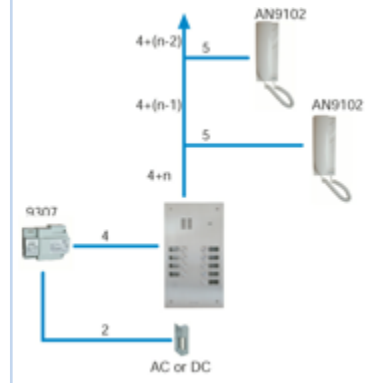

Description	Code
1 phone kit	K4201
2 phone kit	K4202
3 phone kit	K4203
4 phone kit	K4204
5 phone kit	K4205
6 phone kit	K4406
7 phone kit	K4407
8 phone kit	K4408
9 phone kit	K4409
10 phone kit	K4410
Surface mount hood	3505/50
Surface mount hood	3506/50
Extra phone	AN9102S

	Height	Width	Depth
4101 panel	250	136	50
4102 panel	250	136	50
4103 panel	250	136	50
4104 panel	250	136	50
4105 panel	250	136	50
4406 panel	321	181	50
4407 panel	321	181	50
4408 panel	321	181	50
4409 panel	321	181	50
4410 panel	321	181	50
3505/50	254	140	65
3506/50	325	185	65
Phone	220	83	50

with keypad

As vandal resistant panel with built in keypad for user access.

- 110 code keypad with 2 relays
- keypad is illuminated



Description	Code
1 phone kit	K4201/05
2 phone kit	K4402/05
3 phone kit	K4403/05
4 phone kit	K4404/05
5 phone kit	K4405/05
6 phone kit	K4406/05
7 phone kit	K4407/05
8 phone kit	K4408/05
9 phone kit	K4409/05
10 phone kit	K4410/05
Surface mount hood	3505/50
Surface mount hood	3506/50
Extra phone	AN9102S

	Height	Width	Depth
4101/05 panel	250	136	50
4402/05 panel	321	181	50
4403/05 panel	321	181	50
4404/05 panel	321	181	50
4405/05 panel	321	181	50
4406/05 panel	321	181	50
4407/05 panel	349	181	50
4408/05 panel	349	181	50
4409/05 panel	377	181	50
4410/05 panel	377	181	50
3505/50	254	140	65
3506/50	325	185	65
Phone	220	83	50

with proximity

As vandal resistant panel with built in proximity reader and controller for user access.

- 250 users
- Illuminated



Description	Code
1 phone kit	K4201/08
2 phone kit	K4402/08
3 phone kit	K4403/08
4 phone kit	K4404/08
5 phone kit	K4405/08
6 phone kit	K4406/08
7 phone kit	K4407/08
8 phone kit	K4408/08
9 phone kit	K4409/08
10 phone kit	K4410/08
Surface mount hood	3505/50
Surface mount hood	3506/50
Extra phone	AN9102S

	Height	Width	Depth
4201/08 panel	250	136	50
4402/08 panel	321	181	50
4403/08 panel	321	181	50
4404/08 panel	321	181	50
4405/08 panel	321	181	50
4406/08 panel	321	181	50
4407/08 panel	321	181	50
4408/08 panel	321	181	50
4409/08 panel	321	181	50
4410/08 panel	321	181	50
3505/50	254	140	65
3506/50	325	185	65
Phone	220	83	50

2 wire colour video kit



Hands free colour video kit with robust aluminium entrance panel. Lock release and power for lock is not included in the kit.

- Hands free monitor with touch sensitive buttons
- Only 2 wires
- Slim panel only 90mm wide
- Surface mount panel
- Max cable run 75m (with 1.5mm cable)
- Call up to 3 monitors at the same time.

Description	Code
1 video phone kit	
Entrance panel	VC-502
Video monitor	VM-802

Wiring Layout

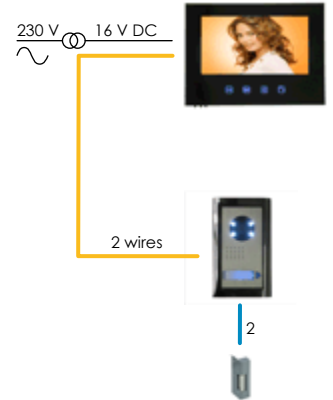

	Height	Width	Depth
Panel	150	90	20
Monitor	150	200	23

Wireless colour video kit



Wireless Audio and video with unlock and monitor functions.

One camera to one monitor 300 meters range in free field. Frankly, you should allow a lot less, because no conditions are 'ideal'.

Works in battery only mode (7 days standby), or mains rechargeable.

Actual distance depends upon local conditions. Consider material of building (metal effects range), the environment (electrical items, mobile phones and other radio devices).

This simple, yet comprehensive, wireless video intercom system allows the user to see and talk with visitors. Ideal for the home or office. Visitors can be seen clearly in colour video via digital video transmission to the portable wireless video handset.

- Desk or wall mount
- Alarm function
- Can store up to 255 images of visitors
- 16 call tone options
- Volume and brightness controls Display of : Battery capacity, Temperature, Calendar
- Pixel : 320 x 240

Description	Code
1 video phone kit	KWV6001

	Height	Width	Depth
Wireless video kit			
Panel	130	95	30
Monitor	85	135	26

Engravable 4000 series video kits



SRS vandal resistant panels have been manufactured to the highest standards since 1987.

- BS316 marine grade stainless steel construction
- Hinged for easier installation
- All kits up to 10 way in stock for same day despatch
- 12V AC/DC power output for locking
- Timed lock release
- Excellent audio quality
- Kits available with up to 60 call buttons
- All SRS video entrance panels are fitted with a colour CCD day/night camera

- Colour video kits available. Change prefix 'K' for prefix 'KC'. Note colour monitor is AV1423/002

Description	Code
1 video phone kit	K4501
2 video phone kit	K4502
3 video phone kit	K4503
4 video phone kit	K4504
5 video phone kit	K4605
6 video phone kit	K4606
7 video phone kit	K4607
8 video phone kit	K4608
9 video phone kit	K4609
10 video phone kit	K4610
Surface mount hood	3505/50
Surface mount hood	3506/50
Extra video phone	AV1423/001
Monitor bracket	AV1423/013

Wiring Layout

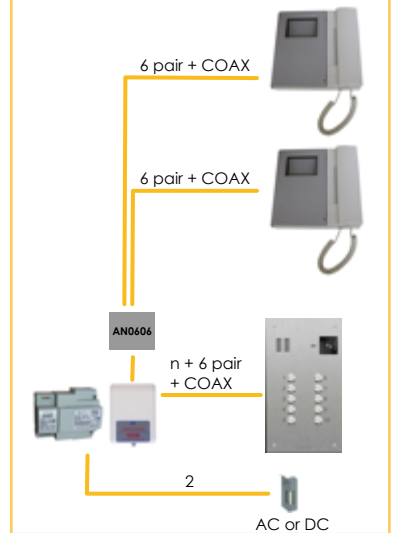

	Height	Width	Depth
4501 panel	250	136	50
4502 panel	250	136	50
4503 panel	250	136	50
4504 panel	250	136	50
4605 panel	321	181	50
4606 panel	321	181	50
4607 panel	321	181	50
4608 panel	321	181	50
4609 panel	321	181	50
4610 panel	321	181	50
3505/50	254	140	65
3506/50	325	185	65
Video phone	220	220	65

with keypad

As vandal resistant panel with built in keypad for user access.

- 110 code keypad with 2 relays
- Keypad is illuminated

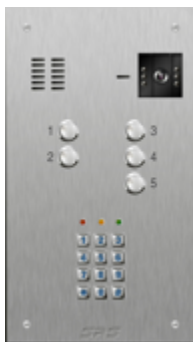

Description	Code
1 video phone kit	K4601/05
2 video phone kit	K4602/05
3 video phone kit	K4603/05
4 video phone kit	K4604/05
5 video phone kit	K4605/05
6 video phone kit	K4606/05
7 video phone kit	K4607/05
8 video phone kit	K4608/05
9 video phone kit	K4609/05
10 video phone kit	K4610/05
Surface mount hood	3506/50

	Height	Width	Depth
4601/05 panel	321	181	50
4602/05 panel	321	181	50
4603/05 panel	321	181	50
4604/05 panel	321	181	50
4605/05 panel	321	181	50
4606/05 panel	321	181	50
4607/05 panel	321	181	50
4608/05 panel	321	181	50
4609/05 panel	321	181	50
4610/05 panel	321	181	50
3506/50	325	185	65

with proximity

As vandal resistant panel with built in proximity reader and controller for user access.

- 250 users
- Illuminated



Description	Code
1 video phone kit	K4601/08
2 video phone kit	K4602/08
3 video phone kit	K4603/08
4 video phone kit	K4604/08
5 video phone kit	K4605/08
6 video phone kit	K4606/08
7 video phone kit	K4607/08
8 video phone kit	K4608/08
9 video phone kit	K4609/08
10 video phone kit	K4610/08
Surface mount hood	3506/50

	Height	Width	Depth
4601/08 panel	321	181	50
4602/08 panel	321	181	50
4603/08 panel	321	181	50
4604/08 panel	321	181	50
4605/08 panel	321	181	50
4606/08 panel	321	181	50
4607/08 panel	321	181	50
4608/08 panel	321	181	50
4609/08 panel	321	181	50
4610/08 panel	321	181	50
3506/50	325	185	65

Name Window 4000 series video kits



SRS vandal resistant panels have been manufactured to the highest standards since 1987.

- BS316 marine grade stainless steel construction
- Hinged for easier installation
- All kits up to 10 way in stock for same day despatch
- 12V AC/DC power output for locking
- Timed lock release
- Excellent audio quality
- Kits available with up to 60 call buttons
- All SRS video entrance panels are fitted with a colour CCD day/night camera

- Colour video kits available. Change prefix 'K' for prefix 'KC'. Note colour monitor is AV1423/002
- SRS Name window panels come with clear polycarbonate windows, where you can print flat numbers
- Name window is illuminated green
- Alternatively stainless steel name plates are available from stock (or engraved same)

Description	Code
1 video phone kit	K4701
2 video phone kit	K4702
3 video phone kit	K4803
4 video phone kit	K4804
5 video phone kit	K4805
6 video phone kit	K4806
7 video phone kit	K4807
8 video phone kit	K4808
9 video phone kit	K4809
10 video phone kit	K4810
Surface mount hood	3505/50
Surface mount hood	3506/50
Extra video phone	AV1423/001
Monitor bracket	AV1423/013

Wiring Layout

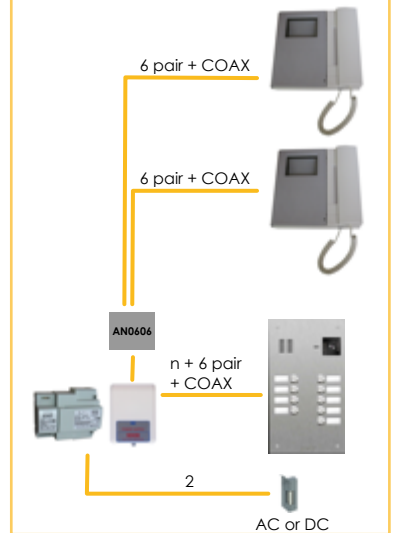

	Height	Width	Depth
4701 panel	250	136	50
4702 panel	250	136	50
4803 panel	321	181	50
4804 panel	321	181	50
4805 panel	321	181	50
4806 panel	321	181	50
4807 panel	321	181	50
4808 panel	321	181	50
4809 panel	321	181	50
4810 panel	321	181	50
3505/50	254	140	65
3506/50	325	185	65
Video phone	220	220	65

with keypad

As vandal resistant panel with built in keypad for user access.

- 110 code keypad with 2 relays
- keypad is illuminated



Description	Code
1 video phone kit	K4801/05
2 video phone kit	K4802/05
3 video phone kit	K4803/05
4 video phone kit	K4804/05
5 video phone kit	K4805/05
6 video phone kit	K4806/05
7 video phone kit	K4807/05
8 video phone kit	K4808/05
9 video phone kit	K4809/05
10 video phone kit	K4810/05
Surface mount hood	3506/50

	Height	Width	Depth
4801/05 panel	321	181	50
4802/05 panel	321	181	50
4803/05 panel	321	181	50
4804/05 panel	321	181	50
4805/05 panel	321	181	50
4806/05 panel	321	181	50
4807/05 panel	349	181	50
4808/05 panel	349	181	50
4809/05 panel	377	181	50
4810/05 panel	377	181	50
3506/50	325	185	65

with proximity

As vandal resistant panel with built in proximity reader and controller for user access.

- 250 users
- Illuminated



Description	Code
1 video phone kit	K4801/08
2 video phone kit	K4802/08
3 video phone kit	K4803/08
4 video phone kit	K4804/08
5 video phone kit	K4805/08
6 video phone kit	K4806/08
7 video phone kit	K4807/08
8 video phone kit	K4808/08
9 video phone kit	K4809/08
10 video phone kit	K4810/08
Surface mount hood	3506/50

	Height	Width	Depth
4801/08 panel	321	181	50
4802/08 panel	321	181	50
4803/08 panel	321	181	50
4804/08 panel	321	181	50
4805/08 panel	321	181	50
4806/08 panel	321	181	50
4807/08 panel	321	181	50
4808/08 panel	321	181	50
4809/08 panel	321	181	50
4810/08 panel	321	181	50
3506/50	325	185	65

DC60 Keypad (100 codes)



2 relays allow the same or different codes to operate (ie for pedestrian gate and vehicle gate). Very versatile, yet easy install makes this the ideal security access keypad.

- Easy to install
- Up to 110 user codes
- Two user modes

Single User:

- 1st Code for relay output 1
- 2nd Code for relay output 2

Multi-User:

- 100 Codes for Relay Output 1
- 10 Codes for Relay Output 2

Description	Code
100 code keypad	DC60SS
12V DC Power supply	1201EX

Wiring Layout

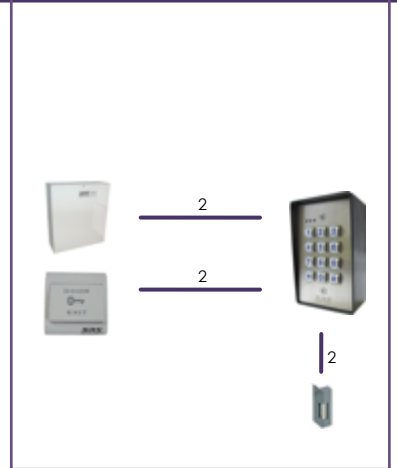

	Height	Width	Depth
Keypad	125	80	50
Boxed PSU	250	215	80

DC250 Stand Alone Access Control



Single door stand alone access control for 250 users.

- Single door access control (2 readers [In & Out])
- 250 card memory
- Card (tokens) individually added / deleted
- Easy to install & easy user programming
- Magstripe or Proximity
- Bank card compatible
- Timed exit request
- Inhibit cards input (time clock)
- Programmable lock timer (01-99 seconds)
- Non volatile data storage for a minimum of 10 years

Power Supply	12VDC
Current Quiescent	20 mA
Operating	60 mA
Operating Temperature	0 - 50 °C
Module Dimensions	83 x 143 x 26 (HWD mm)
Maximum card holders	250
Data Volatility	>5 years
Lock Relay	24V 1 Amp non inductive



Wiring Layout

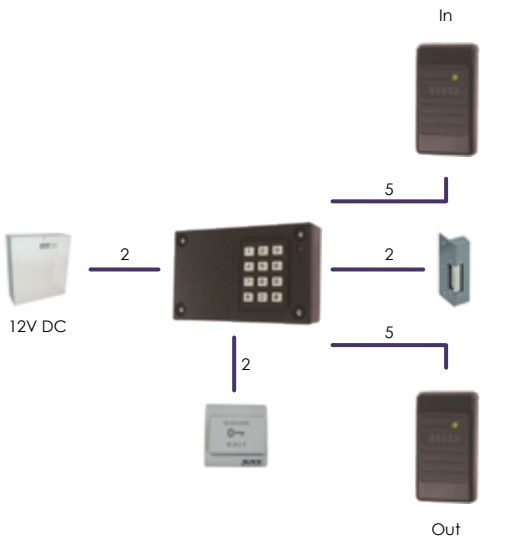

Kit Options

Description	Code	DC250 Controller	6008BGP Prox. reader	40010043 Mag. reader	1201EX PSU	1326/10 Prox. card	1346/10 Prox. tag	22401 Mag. card	615112A Lock release	EMU275-01 Magnetic lock	D108 Break Glass	PB29 Exit button
Magstripe kit	KDC250M	●	●	●				●				
with lock release	KDC250MR	●	●	●				●	●			
with magnetic lock	KDC250MM	●	●	●				●	●	●	●	●
Proximity kit	KDC250P	●	●		●	●						
with lock release	KDC250PR	●	●		●	●			●			
with magnetic lock	KDC250PM	●	●		●	●			●	●	●	●
for door entry panels	KDC250/08	●	●		●							
with tags (not cards)	KDC250PT	●	●		●		●					

Break Glass Units



Description	Code
Break Glass (86x86)	D108
Resettable (86x86)	D115

Key switches



Description	Code
Key switch - keyed alike (86x86)	
Flush	88200
Surface	88200S

Egress Buttons



Description	Code
Plastic surface (86x86)	PB29



Description	Code
Stainless steel button (86x86)	
Flush	80917
Surface	80917S



Description	Code
Green dome button (86x86)	
Door Release	80956-DR
Press For Exit	80956-PTE
Surface mount box	80853SS

Fire Brigade Switch



Description	Code
Crescent FB switch (100x100)	
Flush	FS2-FS
Surface	FS2-SS

Power Supplies



Description	Code
7 DIN mount psu 12V AC / 12V DC	9307.1



Description	Code
12V DC 1 Amp	1201EX
12V DC 2 Amp	1202EM

Relays



Description	Code
2 pole DIN mount relay 12/24V AC/DC	9334



Description	Code
1 pole DIN mount timed relay 12V DC	9327



Description	Code
1 pole DIN mount timed relay 12V DC	9307.2

