

audio kits

systems with engravable panels



system example is K4106

system configuration

vandal resistant with keypad with proximity



DESCRIPTION	PHONE (S)	POWER SUPPLY	PANEL (SIZE)	PANEL (SIZE)	PANEL (SIZE)
1 phone system	AN9102 (1)	9307	4101 (A)	4101/04 (A)	4101/08 (A)
2 phone system	AN9102 (2)	9307	4102 (A)	4102/04 (A)	4102/08 (A)
3 phone system	AN9102 (3)	9307	4103 (A)	4303/04 (D)	4103/08 (A)
4 phone system	AN9102 (4)	9307	4104 (A)	4304/04 (D)	4104/08 (A)
5 phone system	AN9102 (5)	9307	4105 (A)	4305/04 (D)	4305/08 (D)
6 phone system	AN9102 (6)	9307	4106 (A)	4306/04 (D)	4306/08 (D)
7 phone system	AN9102 (7)	9307	4107 (A)	4307/04 (D)	4307/08 (D)
8 phone system	AN9102 (8)	9307	4108 (A)	4308/04 (D)	4308/08 (D)
9 phone system	AN9102 (9)	9307	4109 (A)	4309/04 (D)	4309/08 (D)
10 phone system	AN9102 (10)	9307	4110 (A)	4310/04 (D)	4310/08 (D)

Engravable panels marked red are available within 7 days (assuming you want the panel engraved). All other panels are available within 10 - 15 working days

Don't forget to specify your engraving when you order your vandal resistant panel.

Note : 4101,4102,4103, 4101/04 & 4101/08 back boxes are only 35mm deep.

prefix these stock code numbers with K for the kit stock code number.
eg panel 4101 becomes kit K4101

	SIZE A	SIZE D
height	250	321
width	136	181
depth	50	50

Engravable panels obviously require engraving therefore we only keep 1 phone kits in stock. ALL other panels are engraved to order

1 selecting a kit

For example if you want a 3 phone kit using a 4203 panel, change 4203 to K4203 and you have a 3 phone kit.

K4203 consists of:-

panel	4203	x	1
power supply	9307.1	x	1
lock relay	9307.2	x	1
telephones	AN9102	x	3
clear name plate	NPCLEAR	x	3

2 adding a 2nd entrance

Using the example above, we have a 3 phone kit. Let's assume that the 2nd entrance is required to also have a built in keypad. The keypad is for tenant access.

The 2nd entrance panel in this example will be 4403/04

You will therefore need to order

3 phone kit	K4203	x	1
2nd panel	4403/04	x	1
clear name plate	NPCLEAR	x	3
2 entrance relay	AK5343	x	1

Full equipment actually consists of:-

panel	4203	x	1
power supply	9307.1	x	1
lock relay	9307.2	x	1
telephones	AN9102	x	3
panel	4403/04	x	1
2 entrance relay	AK5343	x	1
clear name plate	NPCLEAR	x	6

wiring layout - 1 entrance panel

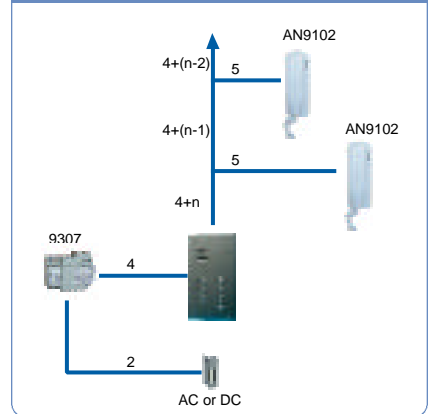

wiring layout - 2 entrance panels

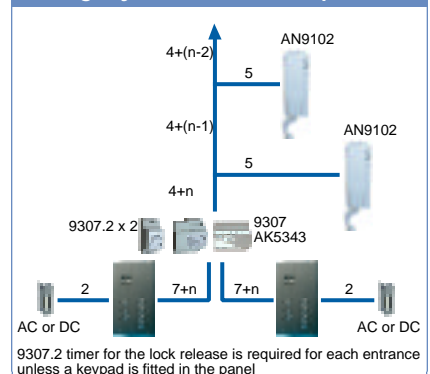

9307.2 timer for the lock release is required for each entrance unless a keypad is fitted in the panel



systems with name window panels



system example is K4205

system configuration

vandal resistant with keypad with proximity



DESCRIPTION	PHONE (S)	POWER SUPPLY	PANEL (SIZE)	PANEL (SIZE)	PANEL (SIZE)
1 phone system	AN9102 (1)	9307	4201 (A)	4201/04 (A)	4201/08 (A)
2 phone system	AN9102 (2)	9307	4202 (A)	4402/04 (D)	4402/08 (D)
3 phone system	AN9102 (3)	9307	4203 (A)	4403/04 (D)	4403/08 (D)
4 phone system	AN9102 (4)	9307	4204 (A)	4404/04 (D)	4404/08 (D)
5 phone system	AN9102 (5)	9307	4205 (A)	4405/04 (D)	4405/08 (D)
6 phone system	AN9102 (6)	9307	4406 (D)	4406/04 (D)	4406/08 (D)
7 phone system	AN9102 (7)	9307	4407 (D)	4407/04 (D1)	4407/08 (D)
8 phone system	AN9102 (8)	9307	4408 (D)	4408/04 (D1)	4408/08 (D)
9 phone system	AN9102 (9)	9307	4409 (D)	4409/04 (D2)	4409/08 (D)
10 phone system	AN9102 (10)	9307	4410 (D)	4410/04 (D2)	4410/08 (D)

Name window panels marked **red** are available for **immediate delivery**. All other panels are available with 10 - 15 working days. Please allow 5 working days for specially engraved name plates.

Note : 4201, 4202, 4203, 4201/04 & 4201/08 back boxes are only 35mm deep.

prefix these stock code numbers with K for the kit stock code number.
eg panel 4205 becomes kit K4205

	SIZE A	SIZE D
height	250	321
width	136	181
depth	50	50

3 surface mounted panel

Continuing the example, let us add the surface mounting hoods for the panels chosen.

The 4203 is an (A) size panel and therefore requires stainless steel hood 3505/50.
The 4403/04 is larger, to accommodate the keypad and is therefore a (D) size panel. It will require the larger stainless steel hood 3506/50

You will therefore need to order

A size hood	3505/50	x	1
D size hood	3506/50	x	1

For a full list of hoods and frames see page 11

4 adding a prox. reader

Panels with suffix /08 have a 40mm square cut out and are suitable for fitting a proximity reader. The proximity reader is for tenant access.

Unless you specify differently, we will assume that you require our reader to be fitted and the panel will have fixings accordingly.

See page 19 for suitable stand alone readers and control equipment. In general you will require a KDC250P kit.

You will therefore need to order

access kit	KDC250P	x	1
------------	---------	---	---

name plates

When you order a vandal resistant door entry kit the panel will come with NPCLEAR name plates.

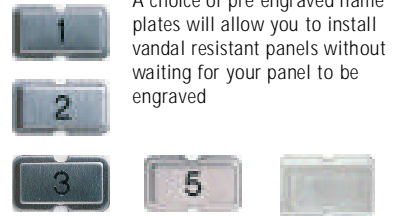

A choice of pre engraved name plates will allow you to install vandal resistant panels without waiting for your panel to be engraved

DESCRIPTION	CODE
name plate engraved 1	NPS01
name plate engraved 2	NPS02
"	"
name plate engraved 19	NPS19
name plate engraved 20	NPS20
name plate engraved RECEPTION	NPSRECEP
name plate engraved SERVICE	NPSSERV
name plate engraved TRADE	NPSTRADE
blank name plate	NP
polycarbonate clear name plate	NPCLEAR



NPCLEAR is a clear polycarbonate (very tough plastic) name window normally used with polished brass panels. The advantage is that you can easily change the tenant name.

audio kits

vandal resistant engravable panel with built in keypad

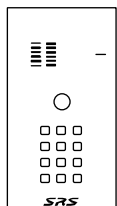

4101/04

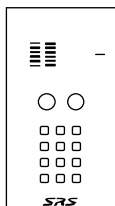

4102/04

Panels are suitable for engraving to your requirements of led as is.

Choice of stainless steel (BS316) panels from 1 call button to 60 call buttons.

The kit with engravable panel is only available as a 1 way, since larger panels will require engraving and cannot therefore be provided in kit form

The front plate is secured to the back box with 4 x SRS stainless steel tamper resistant screws.

for Kits

K4101/*04 1 way

panel dimensions, hoods and frames

No of Buttons	Front plate (H x W)	Back box (H x W x D)	Back box	Hardwood Frame	Flush Hood	Surface Hood
1	250x136	230x116x33	1002	3505/35W	3505/00	3505/50



Connecting DC30M to door entry 4D DC30M

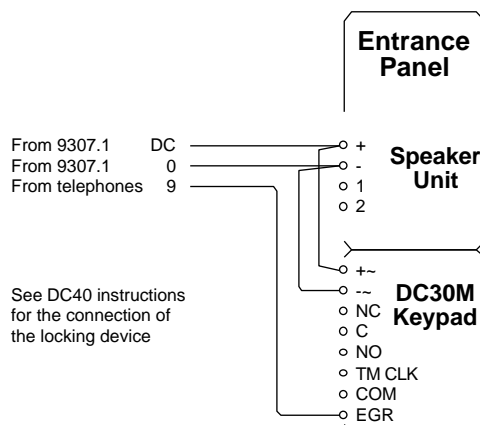

panels for audio kits

vandal resistant name window panels

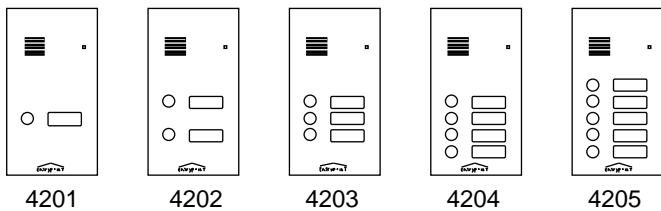

Panels in kits come with clear polycarbonate name windows. You can order stainless steel pre engraved plates with numbering to suit your installation.

Order codes for name plates begin 'NP' eg. a nameplate engraved "15" is stock code "NP15".

Choice of stainless steel (BS316) panels from 1 call button to 5 call buttons.

The front plate is secured to the back box with 4 x SRS stainless steel tamper resistant screws.

Engraving is NOT required.

for Kits

K4201	1 way
K4202	2 way
K4203	3 way
K4204	4 way
K4205	5 way

panel dimensions, hoods and frames

No of Buttons	Front plate (H x W)	Back box (H x W x D)	Back box	Hardwood Frame	Flush Hood	Surface Hood
1 - 3	250x136	230x116x33	1002	3505/35W	3505/00	3505/50
4 - 5	250x136	230x116x50	1003	3505/50W	3505/00	3505/50

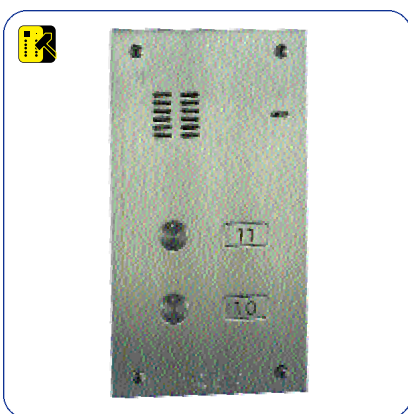



vandal resistant name window panels

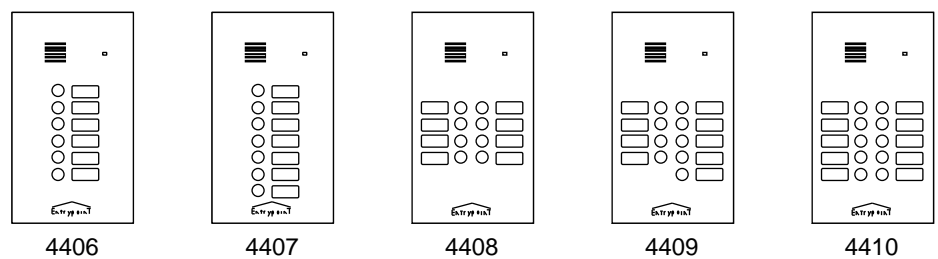

Panels in kits come with clear polycarbonate name windows. You can order stainless steel pre engraved plates with numbering to suit your installation.

Order codes for name plates begin 'NP' eg. a nameplate engraved "15" is stock code "NP15".

Choice of stainless steel (BS316) panels from 6 call buttons to 10 call buttons.

The front plate is secured to the back box with 4 x SRS stainless steel tamper resistant screws.

Engraving is NOT required.

for Kits	
K4406	6 way
K4407	7 way
K4408	8 way
K4409	9 way
K4410	10 way

panel dimensions, hoods and frames

No of Buttons	Front plate (H x W)	Back box (H x W x D)	Back box	Hardwood Frame	Flush Hood	Surface Hood
1 - 14	321x181	301x161x50	1007	3506/50W	3506/00	3506/50



audio door entry